

Original Owner's Manual



Base Line and Blaster

Introduction

Meyer Products LLC has published this manual to help you get maximum performance from your Meyer Spreader and familiarize you with the features designed for efficiency and safety; be sure you recognize and understand them. Follow recommended operation and maintenance instructions. Failure to do so may result in voiding your warranty.

DO NOT EQUIP ANY VEHICLE WITH A SPREADER WITHOUT CONSULTING VEHICLE MANUFACTURERS' RECOMMENDATIONS.

Vehicles equipped with Meyer spreaders installed may be so equipped as to meet vehicle manufacturers' specifications and recommended options for materials spreading use. Most vehicle manufacturers insist that vehicles which are to be used for ice control be equipped with certain options and accessories, and it is so stated in vehicle manufacturer specifications for snow plow application.

Your spreader will come equipped with a cover that will protect your de-icing material from rain or snow; this can be removed simply by detaching the holding clamps on the sides of the hopper. Always replace cover after filling to prevent saturation of material from rain or snow.

WARNING: NEVER leave materials in hopper for long periods of time as de-icing materials will attract atmospheric moisture and may clump together.

CAUTION: Sweep area clear of foreign objects or obstacles that could cause personal injury. Keep other persons and animals out of area to be spread.

WARNING: Deployment of an air bag while using a Meyer Spreader will not be covered under Meyer Products' warranty. We also recommend that, for optimum performance, vehicles used for ice control be equipped with:

- Four-Wheel Drive
- Minimum 60 Amp Alternator or larger
- Minimum 70 Amp Battery or larger (550 C.C.A.)
- Mud and Snow Tires
- Increased Radiator Cooling
- Automatic Transmission
- Power Brakes
- Power Steering

Under the continuing Meyer Product Improvement Plan, Meyer Products LLC reserves the right to change design details and construction without prior notice and without incurring any obligation.

TORQUE CHART FOOT



Bolt Nut Size	Gr. 2 	Gr. 5 	Gr. 8 
1/4-20	4-5		
5/16-18	9-11		
3/8-16	17-20	26-29	
7/16-14		42-46	60-66
1/2-13		64-72	99-100
5/8-11		127-141	179-198

Table of Contents

Introduction	2
Warranty	4
Registration	5
Safety Definitions & Warnings	6-7
Safety Decals	8
Vehicle Requirements	9
Base Line	
Component Identification	10-11
Receiver Mount	12
Installation.....	13
Controller.....	14-15
Blaster	
Component Identification	16-19
Receiver Mount	20-21
Installation.....	22
Controller.....	23
Spreader Maintenance	24
Spreader Troubleshooting	25
Spreader Materials	25
Spreader Calibration	26-27
Warranty	
Base Line	28-29
Blaster	30-31
EC Declaration of Conformity	32

Warranty

Your operator's manual provides essential information on safety, operation, and maintenance. Failure to follow this operator's manual may result in damage to your equipment and affect your warranty.

Base Line and Blaster spreaders are both covered under the Meyer warranty.

- Base Line has a 2 year warranty
- Blaster has a 5 year warranty*

Meyer's warranty covers manufacturing defects including welding, electrical, lights, controllers, and more.

The warranty does not cover abuse, misuse, bends, twists, paint, rust, corrosion, wear & tear, loss of time, incidentals, or similar issues.

For further information on the warranty, please review the pages 28-31.

All warranty work must be done by an authorized Meyer dealer. Your local dealer can be found by visiting...

www.meyerproducts.com/dealer-locator.

* Your Blaster spreader must be registered to receive the 5 year warranty.

Registration

Once registered (Blaster only*), you will be provided with a registration ID. Meyer recommends completing the fields below for future reference.

Registration ID _____

Purchase Date _____

Purchased From _____

Model _____

Serial Number _____

*Only the Blaster model requires registration. Please retain proof of purchase and present to a Meyer dealer for proof of warranty on Base Line models.

Safety Definitions & Warnings

SAFETY DEFINITIONS



This is the safety alert symbol. It is used to alert you to potential personal injury hazards. Obey all safety messages that follow this symbol to avoid possible injury or death.



DANGER indicates an imminently hazardous situation which, if not avoided, will result in death or serious injury.

















WARNING indicates a potentially hazardous situation which, if not avoided, could result in death or serious injury.











CAUTION indicates a potentially hazardous situation which, if not avoided, may result in minor or moderate injury.

CAUTION

CAUTION used without the safety alert symbol indicates a potentially hazardous situation which, if not avoided, will result in property damage.

1	 DANGER	NEVER stand or ride on the spreader. Failure to comply will result in death or serious injury.
2	 DANGER	Keep hands, feet, and clothing away from power driven parts. Failure to comply will result in death or serious injury.
3	 DANGER	Make sure spreader is completely shut off and all movement has stopped before attempting to clean, service or unplug. Failure to comply will result in death or serious injury.
4	 DANGER	NEVER enter hopper while spreader is operating or capable of being operated. Failure to comply will result in death or serious injury.
5	 WARNING	NEVER operate or service your spreader without first CAREFULLY reading the Owner's Manual. It is CRITICAL for your safety to ALWAYS obey EVERY warning in the manual and follow EVERY instruction EXPLICITLY. Failure to comply could result in death or serious injury.
6	 WARNING	Never leave operator's position without first completely turning off spreader, disengaging PTO, shutting off hydraulic valve and setting vehicle parking brake. Failure to comply will result in death or serious injury.
7	 WARNING	Never operate spreader without all shields, guards, and safety decals in place. Failure to comply will result in death or serious injury.
8	 WARNING	Spreader should only be operated by personnel trained in the safe use and transportation of this equipment.
9	 WARNING	The spreader should NEVER be used for any other purpose other than spreading ice melting or traction products on streets, parking lots and driveways. Failure to comply will result in property damage, death or serious injury.
10	 WARNING	Inspect spreader assembly and mounting components and fasteners for wear and damage before and after each use. Worn or damaged components or fasteners could allow spreader to break free from the transport vehicle. Failure to comply will result in death or serious injury.
11	 WARNING	Transport vehicle must not be operated when overloaded. In all cases, the loaded vehicle weight, including the entire spreader system, all aftermarket accessories, driver, passenger, options, nominal fluid levels, and cargo must not exceed the front/rear Gross Axle Weight Rating (GAWR), and total Gross Vehicle Weight Rating (GVWR). These weights ratings are specified on the safety compliance certification label on the driver's side door opening. Failure to comply will result in death or serious injury.
12	 WARNING	Spreader may tip over or fall. Spreader should be solidly supported when being mounted, dismounted, moved, or stored. Failure to comply will result in death or serious injury.
13	 WARNING	Operator, bystanders and pets should be kept at least 50 feet (15m) away from spreader during operation. Failure to comply will result in death or serious injury.
14	 WARNING	SAFETY PRECAUTIONS should be used when hydraulic system is operating or being serviced. Hydraulic fluid under pressure can cause a skin injection injury. If you are injured by hydraulic fluid, get medical attention immediately. Failure to comply will result in death or serious injury.
15	 WARNING	Engine exhaust contains lethal fumes. Breathing these fumes, even in low concentrations, can cause death. Never operate engine in an enclosed area without venting the exhaust to the outside. Failure to comply will result in death or serious injury.

Safety Definitions & Warnings

16	 WARNING	Gasoline is highly flammable and gasoline vapor is explosive. Never smoke while working on vehicle or spreader. Keep all open flames away from gasoline tank and lines. Wipe up any spilled gasoline immediately. Failure to comply will result in death or serious injury.
17	 WARNING	NEVER operate the spreader gasoline engine without first CAREFULLY reading the Owner's Manual. It is CRITICAL for your safety to ALWAYS obey EVERY warning in the manual and follow EVERY instruction EXPLICITLY. Failure to comply will result in death or serious injury.
18	 CAUTION	A driver's first responsibility is the safe operation of the vehicle and spreader. The most important thing you can do to prevent a crash is to avoid distractions and pay attention to the road. Wait until it is safe to operate mobile communication equipment such as cell phones, two way radios, etc. Failure to comply will result in injury.
19	 CAUTION	Vehicle must conform to all local, state, and national regulations regarding the use of reflective markings and flashing lights. Failure to comply will result in injury.
20	 CAUTION	Batteries normally produce explosive gases which can cause personnel injury. Therefore, do not allow flames, sparks or lit tobacco to come near the battery. When charging or working near a battery, always cover your face and protect your eyes, and also provide ventilation. Batteries contain sulfuric acid which burns skin, eyes, and clothing. Failure to comply will result in injury.
21	CAUTION	Never transport spreader with spinner in the raised position. Failure to comply will result in property damage.
22	CAUTION	Installation of a Meyer spreader may affect your new vehicle warranty. Before beginning spreader installation verify mounting method is acceptable to your vehicle manufacturer. Failure to comply will result in property damage.
23	CAUTION	Warranty does not apply to a Meyer spreader product which has been negligently or improperly assembled or installed. Failure to comply will result in property damage.
24	 CAUTION	CAUTION: To avoid harm to vehicles electrical system always disconnect battery before beginning installation. DO NOT BURN holes or WELD vehicle frame. This may cause frame failure. Failure to comply will result in property damage.
25	 CAUTION	CAUTION: To avoid harm to spreader electrical system always disconnect battery before beginning installation or service. Do not operate spreader with a missing, discharged or dead battery. Failure to comply will result in property damage.
26	 CAUTION	The Meyer spreader electrical system contains several automotive style fuses. If a problem should occur and fuse replacement is necessary, the replacement fuse must be of the same type and amperage as the original. Installing a fuse with a higher rating can damage the system and could cause a fire. Failure to comply will result in property damage.
27	 CAUTION	Spreader is not designed to be chassis mounted. Do not support spreader by body jacks alone. Spreader must be installed directly onto truck bed. Failure to comply will result in property damage.

SAFETY DEFINITIONS



This is the safety alert symbol. It is used to alert you to potential personal injury hazards. Obey all safety messages that follow this symbol to avoid possible injury or death.



DANGER indicates an imminently hazardous situation which, if not avoided, will result in death or serious injury.



WARNING indicates a potentially hazardous situation which, if not avoided, could result in death or serious injury.

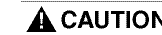

CAUTION indicates a potentially hazardous situation which, if not avoided, may result in minor or moderate injury.



CAUTION used without the safety alert symbol indicates a potentially hazardous situation which, if not avoided, will result in property damage.

Safety Decals

These safety alert decals are used to alert you of potential personal injury hazards. Obey all safety messages that follow this symbol to avoid possible injury or death.



DANGER Conveyor
This decal alerts all to the danger of serious personal injury or death while servicing or cleaning this equipment without first turning off or disconnecting all power sources.



CAUTION
This decal cautions all to observe general safety procedures when operating, moving, storing, cleaning or servicing this equipment.



DANGER Spinner
This decal alerts all to the danger of any person being near the spinner while it is turning where serious personal injury could result if struck by flying debris.



CAUTION Empty Hopper
This decal cautions all to only lift or move equipment when hopper is empty to prevent the risk of serious personal injury or property damage.



CAUTION
This decal cautions all to the risk of the tank containing hazardous chemicals. Operators should wear appropriate PPE when contact with chemicals is possible.



CAUTION Fork Length
This decal cautions all to make sure fork lift arms extend a minimum of 4"(10.2cm) past both brackets before lifting or moving equipment to prevent the risk of serious personal injury or property damage.

Vehicle Requirements

For installation Base Line 240 & 400 series spreaders:

1. This product line can be installed on any vehicle with a class 3 hitch receiver that will accept a 2" square tube and has a tongue weight rating of at least 500 lbs (227 kg).
2. If your vehicle is not factory equipped with a hitch, we recommend taking it to a reputable trailer hitch installation shop or your vehicles dealership.

For installation Base Line 750 series spreaders:

1. Due to the size and capacity of these spreaders we recommend installation on full size trucks with a 1/2 Ton rating or higher.
2. This product line can be installed on any vehicle with a class 3 hitch receiver that will accept a 2" square tube and has a tongue weight rating of at least 500 lbs (227 kg)
3. If your vehicle is not factory equipped with a hitch, we recommend taking it to a reputable trailer hitch installation shop or your vehicles dealership.

For installation Blaster 350 series spreaders:

1. This product line can be installed on any vehicle with a class 3 hitch receiver that will accept a 2" square tube and has a tongue weight rating of at least 500 lbs (227 kg).
2. If your vehicle is not factory equipped with a hitch, we recommend taking it to a reputable trailer hitch installation shop or your vehicles dealership.

For installation Blaster 750 series spreaders:

1. Due to the size and capacity of these spreaders we recommend installation on full size trucks with a 1/2 Ton rating or higher.
2. This product line can be installed on any vehicle with a class 3 hitch receiver that will accept a 2" square tube and has a tongue weight rating of at least 500 lbs (227 kg)
3. If your vehicle is not factory equipped with a hitch, we recommend taking it to a reputable trailer hitch installation shop or your vehicles dealership.

As with any vehicle accessory, please refer to your owner's manual to verify that the GVWR (Gross Vehicle Weight Rating) will not be exceeded, especially if this product will be used in conjunction with the mounted equipment. If equipment is mounted to vehicle with other than stock hardware or components, we the manufacturer cannot and will not be held responsible for damages. Also, check your vehicle owner's manual to be sure that the installation of "aftermarket" accessories will not void the manufacturer's factory warranty.

Base Line Component Identification

Base Line 240/400/750

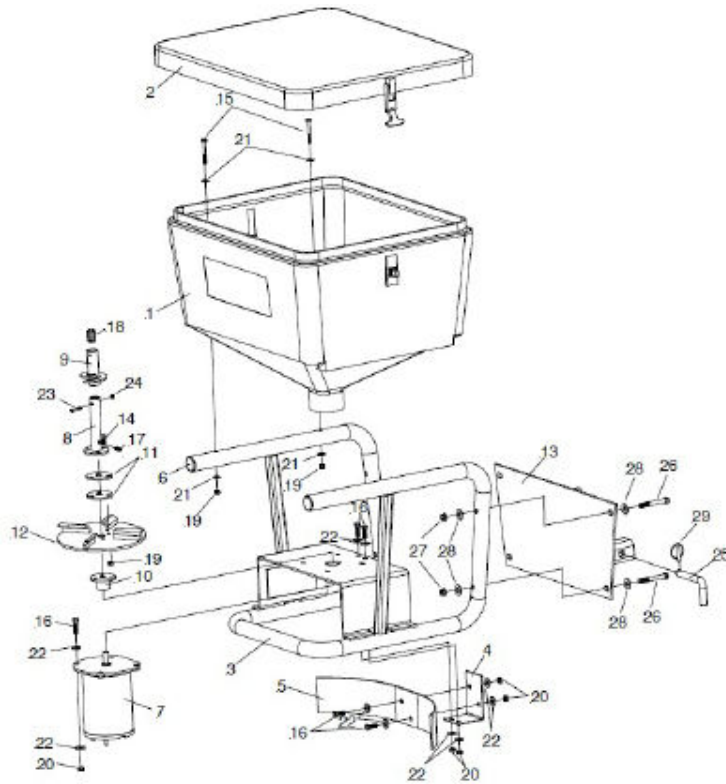

Base Line Component Identification

Item	Part No.	Qty.	Description
1	31101	1	• 240 Hopper
1	36101	1	• 400 Hopper
1	39102	1	• 750 Hopper
2	31102	1	• 240 & 400 Hopper Cover
2	39102	1	• 750 Hopper Cover
3	34413	1	• Spreader Frame
4	34415	1	• Deflector Bracket
5	34401	1	• Deflector
6	34416	2	• Tube Plug
7	36402A	1	• Motor 12V D.C.
8	34011	1	• Auger Center Post
9	34302	1	• Brush Auger Rock Salt
10	36152	1	• Spinner Hub Weldment
11	36158	2	• Spinner Mounting Plate
12	36415	1	• Spinner (Poly)
13	34414	1	• 240/400 Hitch Assembly
14	20007	3	• Bolt H 1/4 - 20 x 1-1/2" Gr. 2
15	20010	4	• Bolt H 1/4 - 20 x 2-1/4" Gr. 2
16	20027	8	• Bolt H 5/16 - 18 x 1" Gr. 2
17	21834	1	• Set Screw 3/8-24 x 3/8

Item	Part No.	Qty.	Description
18	22728	1	• Set Screw 3/4-10 SS
19	20303	7	• Locknut 1/4 Esna
20	20313	8	• Locknut 5/16 Esna
21	20351	8	• Flatwasher 1/4
22	20352	16	• Flatwasher 5/16
23	22996	1	• Bolt H 1/4-20 x 2" SS
24	22997	1	• Locknut 1/4-20 SS
	08259	1	• 240/400 Hitch Hardware Bag
25	11101	1	•• Hinge Pin
26	20069	4	•• Bolt H 3/8-16 x 3"
27	20314	4	•• Locknut 3/8
28	20353	8	•• Flatwasher 3/8
29	22083	1	•• Linch pin
	31104	1	• 240/400 Wiring Kit
30	34405	1	•• Controller
31	36240	1	•• Socket Assy. w/Mtg. Plate
32	36241	1	•• Plug Assembly
33	36242	1	•• Wire, Red 264"
34	36247	1	•• Wire, Red 96"

Parts indented are included in the assembly under which they are indented.

Base Line Receiver Mount

CAUTION: Always disconnect battery before beginning installation.

CAUTION: This spreader is a large heavy item that should be installed with an assistant. As with any new equipment installation read and understand all instructions prior to starting the job, and do not hurry through it. A correct installation now can save time and money later.

Check contents against the parts list to determine all are correct and included, and also to familiarize yourself with them.

Locknuts are furnished. **DONOT** tighten bolts and nuts until installation is complete (unless otherwise specified), then be sure to tighten all attaching parts per specified torque chart.

When ordering parts, furnish Part No., Name and Description.

1. Assemble Hitch Assembly (13) to Spreader Frame (3) using 3/8-16 x 3" Bolt (26), 3/8 Flatwasher (28) and 3/8 Locknut (27)
2. Slide Spreader Assembly into receiver hitch on vehicle and insert Hinge Pin (25) through corresponding hole on receiver and Hitch Assembly (13). Secure Hinge Pin (25) with Linch Pin (29).
3. Tighten all bolts to their required torque using the chart below.



Base Line Installation

1. Choose a location for the Controller (30) that is convenient for the driver. Make certain Controller (30) is grounded by attaching ground wire to a good vehicle ground.
2. Attach the eyelet end of the 96" (2.5m) red wire (34) to the positive terminal of the battery and route the plug end to the location of the speed control. **DONOT** attach to Controller (30) at this time.
3. Take the 264" (6.7m) red wire (33) and route the larger rubber plug end to the rear of the truck, securely tying to vehicle frame. Be certain wire is clear of any sharp or moving objects or the vehicle's exhaust system.
4. **CAUTION:** Some vehicles are redesigned to operate with exhaust temperatures as high as 1800°F (982°C). This can easily damage any wires which are routed too closely or allowed to come in contact with any portion of the exhaust system. Be certain all wires are securely installed away from the exhaust system.
5. Be certain the motor leads will not be strained when the plug is attached. Plug the 264" (6.7m) red wire (33) into the socket. Secure black wire from socket (31) to a good grounding point on vehicle frame. Clean all rust or undercoating from this area.
6. Attach red wire from motor plug (32) to positive (+) terminal of motor. Tap this connection! Attach black wire to negative (-) terminal of motor. Push plug (32) into the socket (31).
7. Perform the motor run test as described in paragraphs 3 and 4 of the "Caution" above. If the motor operates 264" (6.7m) red wire (33) and 96" (2.5m) red wire (34) can be attached to their respective terminals on the Controller (30).
8. Meyer Products assumes no responsibility for installations not made in accordance with these instructions.

Base Line Controller

Installation

The BL Controller is an electronic module powered off the switched ignition circuit +12Vdc and supplying the heavy motor current from the +12Vdc battery circuit. The controller will only function with the ignition key in the ON state. The controller is connected to the spinner motor and vibration motors via a custom wire harness that is designed to handle the high motor currents. The controller can be mounted under the vehicle dash using mounting hardware that is provided in the kit. The controller is weatherproof and can be mounted in areas where it will get wet. The controller includes 5 wires as follows:

1. Ignition wire Blue (power to the controller through switched ignition).
2. Power wire Red (power to the controller directly from 12V battery)
3. Output wire White (connects to the spreader motor positive)
4. Output wire Green (connects to the option 1 vibrator motor)
5. Ground wire Black (provides ground for the controller).

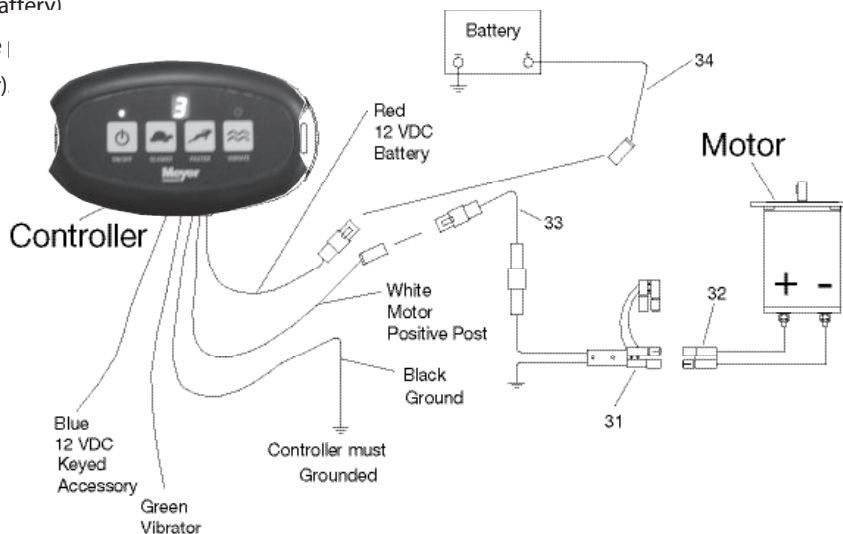

Base Line Controller

The controller will provide the spreader motor with multiple speed options per following:

ON/OFF	Depress the button once to enable the spreader motor operation. Spreader motor will automatically be activated with 5 full power Blasts and then stop. The GREEN LED located above this switch will illuminate.
ON/OFF	Depress the button a second time and the spreader motor operation will stop. The GREEN LED located above this switch will stop illuminating.
FASTER	Once spreader is activated, by depressing the FASTER button momentarily for the first time, the motor will start rotating at the lowest speed. If the button is depressed again, motor will gain speed. Faster button can be depressed momentarily or held depressed to achieve maximum speed. There are ten programmed speed settings that increase the speed in increments of 10%. The GREEN LED located above the I/O button will flash in unison with the speed setting. The fastest speed causes the GREEN LED to flash at a rate of 10 flashes every second.
SLOWER	By depressing the SLOWER button, the motor speed will decrease. There are ten programmed speed settings that decrease the speed in increments of 10%. SLOWER button can be depressed momentarily or held depressed to slow down the motor until it comes to a halt. The LED located in the center will provide a number for the speed setting. 1 is slowest and 10 is fastest.
VIBRATE (On/Off)	Depress the button once to enable the vibrate motor operation. The GREEN LED located above this switch will illuminate at full intensity.
VIBRATE (On/Off)	Depress the button a second time and the vibrate motor operation will stop. The GREEN LED located above this switch will stop illuminating.

Controller will only be activated while ignition switch is at ON position. If the unit is wired into a keyed power source. There will be one inline fuse located at the incoming power wire harness. This will be a 20A automotive ATO fuse. This 20A fuse protects the spreader motor and/or vibrate motor from over current conditions. In the event that the fuse has opened circuited, replacement of the fuse will be required in order to restore the operation. Fuse replacement is facilitated with a pair of needle nosed pliers. The controller also has overload protection built into the circuit board. If an overload occurs the green LED above the I/O button will turn red and will begin to flash. To reset, turn off controller and clear obstruction from spreader then turn controller back on.

Blaster Component Identification

Blaster 350/350RS

Note: 350SAugerExtension(16) must be removed when using salt only. If it is not removed this may cause the motor to stall.

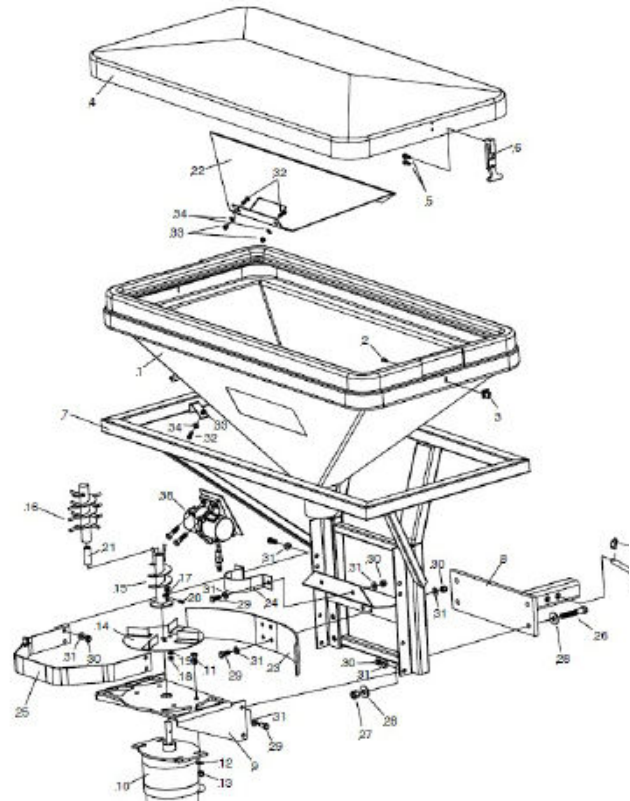
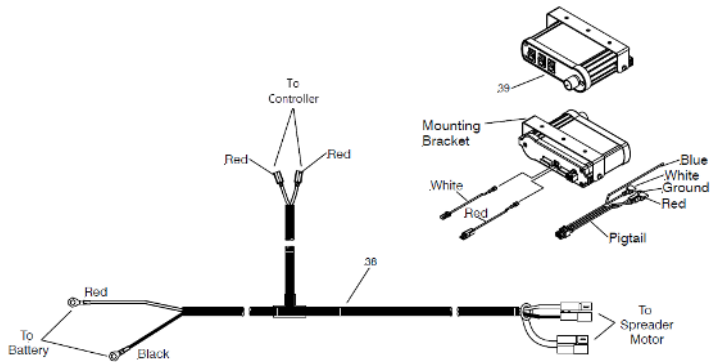

Blaster Component Identification

Item	Part #	Part #	Qty.	Description	Item	Part #	Part #	Qty.	Description	Item	Part #	Part #	Qty.	Description
	32000	37000	1	Blaster Assembly	23	22726	22726	1	• Set Screw 5/16" SS	40	22731	22731	1	•• Hinge Pin w/ Clip
1	32100	32100	1	• Hopper Assembly	24	22728	22759	1	• Set Screw 3/4-10 x 2 SS		32217	32217	2	•• Tie Down Hook
2	22729	22729	2	•• Bolt 1/4-20 x 5/8" SS	25	-	34601	1	• Baffle Plate		32216	32216	2	•• Ratchet Tie Down
3	34407	34407	2	•• Latch Hook	26	34401	34401	1	• Deflector	41	-	34602	1	• Vibrator
4	34200	34200	1	• Lid Assembly	27	34402	34402	1	• Hopper Collar					
5	22725	22725	4	•• Bolt 1/4-20 x 3/4" SS	28	34400	34400	1	• Motor Guard					
6	34408	34408	2	•• Rubber Latch	29	22736	22736	4	• Bolt 1/2-13 x 3" SS					
7	32200	32200	1	• Frame Assembly	30	22732	22732	4	• Locknut 1/2-13 SS					
8	35001	35001	1	• Hitch Weldment	31	22733	22733	8	• Flatwasher 1/2" SS					
9	34101	34101	1	• Motor Mount	32	22737	22737	18	• Bolt 3/8-16 x 1" SS					
10	34102	34102	1	• Motor	33	22735	22735	18	• Locknut 3/8-16 SS					
11	22730	22730	4	• Bolt 3/8-16 x 1-1/4" SS	34	22734	22734	35	• Flatwasher 3/8" SS					
12	22734	22734	4	• Flatwasher 3/8" SS	35	22725	-	2	• Bolt 1/4-20 x 3/4" SS					
13	22735	22735	4	• Locknut 3/8-16 SS	35	-	22725	8	• Bolt 1/4-20 x 3/4" SS					
14	36415	36415	1	• Spinner	36	22727	-	2	• Locknut 1/4-20 SS					
15	34011	34011	1	• Auger Center Post	36	-	22727	6	• Locknut 1/4-20 SS					
16	-	34604	1	• Auger Extension	37	22724	-	2	• Flatwasher 1/4" SS					
17	34306	34306	1	• Auger Extension	37	-	22724	6	• Flatwasher 1/4" SS					
18	22996	22996	1	• Bolt 1/4-20 x 2" SS		32218	32218	1	• Carton Accessory Parts					
19	22725	22725	3	• Bolt 1/4-20 x 3/4" SS	38	34106	34106	1	•• Wire Harness					
20	22727	22727	3	• Locknut 1/4-20 SS	39	22800	22800	1	•• Controller					
21	22997	22997	1	• Locknut 1/4-20 SS										
22	22724	22724	3	• Flatwasher 1/4" SS										

Parts indented are included in the assembly under which they are indented.

Blaster Component Identification

Blaster 750R/750RS

Note: 350S Auger Extension (17) must be removed when using salt only. If it is not removed this may cause the motor to stall.

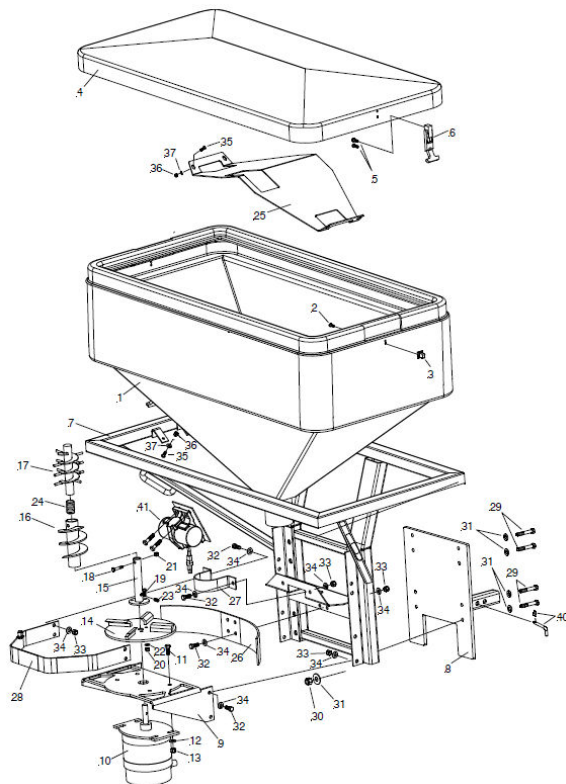
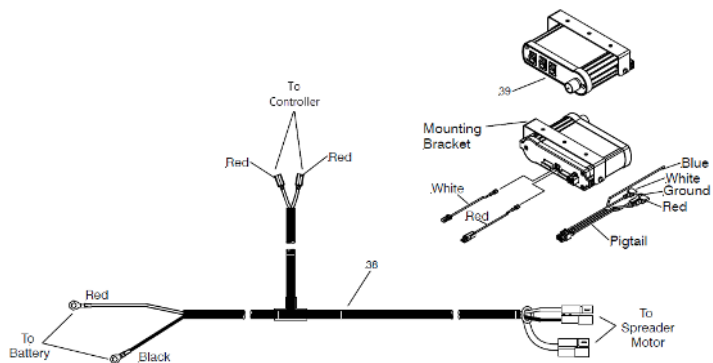

Blaster Component Identification

Blaster 750R/750RS

Item	Part #	Part #	Qty.	Description
	33750	39010		Blaster Assembly
1	33100	33100	1	• Hopper Assembly
2	22729	22729	2	• Bolt 1/4-20 x 5/8" SS
3	34407	34407	2	• Latch Hook
4	34200	34200	1	• Lid Assembly
5	22725	22725	4	• Bolt 1/4-20 x 3/4" SS
6	34408	34408	2	• Rubber Latch
7	32200	32200	1	• Frame Assembly
8	35010	35010	1	• Hitch Weldment
9	34101	34101	1	• Motor Mount
10	34102	34102	1	• Motor
11	22730	22730	4	• Bolt 3/8-16 x 1-1/4" SS
12	22734	22734	4	• Flatwasher 3/8" SS
13	22735	22735	4	• Locknut 3/8-16 SS
14	36415	36415	1	• Spinner
15	34011	34011	1	• Auger Center Post
16	34306	34306	1	• Auger
17	-	34603	1	• Auger Extension
18	22996	22996	1	• Bolt 1/4-20 x 2" SS

Item	Part #	Part #	Qty.	Description
19	22725	22725	3	• Bolt 1/4-20 x 3/4" SS
20	22727	22727	3	• Locknut 1/4-20 SS
21	22997	22997	1	• Locknut 1/4-20 SS
22	22724	22724	3	• Flatwasher 1/4" SS
23	22726	22726	1	• Set Screw 5/16" SS
24	22728	22759	1	• Set Screw 3/4-10 x 2 SS
25	-	34601	1	• Baffle Plate
26	34401	34401	1	• Deflector
27	34402	34402	1	• Hopper Collar
28	34400	34400	1	• Motor Guard
29	22736	22736	8	• Bolt 1/2-13 x 3" SS
30	22732	22732	8	• Locknut 1/2-13 SS
31	22733	22733	16	• Flatwasher 1/2" SS
32	22737	22737	18	• Bolt 3/8-16 x 1" SS
33	22735	22735	18	• Locknut 3/8-16 SS
34	22734	22734	35	• Flatwasher 3/8" SS
35	22725	-	2	• Bolt 1/4-20 x 3/4" SS
35	-	22725	8	• Bolt 1/4-20 x 3/4" SS
36	22727	-	2	• Locknut 1/4-20 SS

Item	Part #	Part #	Qty.	Description
36	-	22727	6	• Locknut 1/4-20 SS
37	22724	-	2	• Flatwasher 1/4" SS
37	-	22724	6	• Flatwasher 1/4" SS
	32218	32218	1	• Carton Accessory Parts
38	34106	34106	1	• Wire Harness
39	22800	22800	1	• Controller
40	22731	22731	1	• Hinge Pin w/ Clip
	32217	32217	2	• Tie Down Hook
	32216	32216	2	• Ratchet Tie Down Strap
41	-	34602	1	• Vibrator

Parts indented are included in the assembly under which they are indented.

Blaster Receiver Mount

The Blaster 350/350S/750R/750RS is a dedicated 2" receiver hitch mounts salt spreader. Prior to installation, be certain that the vehicle receiver is in good working order, is rated for at least a 500 lb. (227kg) tongue load, and is fastened to the vehicle securely.

CAUTION-This spreader is a large heavy item that should be installed with an assistant. As with any new equipment installation read and understand all instructions prior to starting the job, and do not hurry through it. A correct installation now can save time and money later.

1. Using an assistant remove the spreader unit and all loose components from the packaging and set cover aside until installation is complete. Retain original packaging for storage purposes. Locate the large hitch pin and cotter clip (40) from the hardware package. Set these items aside, as they will be used later during the installation.
2. Inspect the vehicle's receiver tube and check for rust, dirt, or foreign debris that may have collected in it. If there are any blockages clean with compressed air and a wire brush.
3. Apply good quality grease to the inside of the receiver tube, this will prevent rusting and make the spreader easier to remove at the end of the season.
4. The framework will have four 1/2-13x3" SS Bolts (29) already installed in the mounting holes for the hinger. Remove the 1/2-13 SS Locknuts (30) and 1/2" SS Flat washers (31) and apply a light oil to the threads, this will make assembly easier; yet will not affect the locking properties of the safety nuts. Place the hitch assembly over the bolts, replace the nuts and washers and fully tighten.
5. Lift the spreader unit upright (hopper opening facing up) with mounting tube pointed toward the truck.
6. Slowly slide spreader mounting tube into the vehicle's receiver until the through holes in receiver match through holes in spreader. (See note below)
7. Insert the large hitch pin (40) through the receiver tube and spreader mounting tube. Secure with the cotter clip (40). **WARNING**-The cotter clip (40) must be in place for safe operation.
8. Place the cover over the hopper and secure clamps on left and right sides.
9. Use the Ratchet Tie Down Strap and Tie Down Hooks to tie spreader to vehicle frame to eliminate any rocking of the spreader.

NOTE:

- The spreader mounting tube has two pre-punched hole sets to provide some adjustment when installing the unit.
- Always use the hole set that places the unit closest to the vehicle but without touching it.
-

WARNING-Never attempt to drill new holes in the spreader mounting tube, contact your local trailer hitch supplier about relocating or replacing your current hitch, if mounting problems occur.

Blaster Receiver Mount

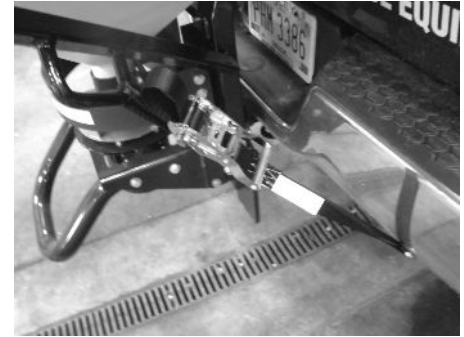
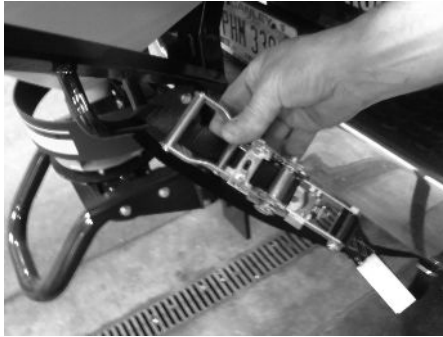

Blaster Installation

1. Locate the wire harness (38) and begin to route it from the rear of the vehicle to the front. The molded rubber plug indicates the rear of the harness, closest to the spreader. Use frame holes and frame supports as lashing points. Do not attach to fuel or brake lines. Avoid wire-runs along exhaust system or hot engine parts. Melting damage to the harness can occur in the proximity of extreme heat.
2. Mount the rubber plug under the rear bumper. Position this plug toward the center of the vehicle.
3. Place the Harness (38) portion that connects to the battery along the firewall and fender well, but do not connect yet.
4. Drill a 1" diameter hole through the firewall. This hole will be used to route the controller portion of the harness into the vehicle. Before drilling, always check to see what is on the other side.
5. Push the controller portion of harness through the hole in the firewall that was previously drilled.
NOTE: The controller end will have 2 plugs on it, but only 1 plug can pass through the firewall at a time.
6. Move to engine compartment. Connect power lead to battery: RED WIRE (+) positive, BLACK WIRE (-) negative. Coat the connections with dielectric grease to prevent corrosion and build up. Check harness marked 'battery' for voltage by temporarily removing the red tape affixed to it.
7. Connect the blue wire from pigtail to brake light. Connect white wire from pigtail to optional vibrator harness if equipped. Connect red wire on pigtail to a 12 volt keyed accessory. Connect black ground wire to ground. Connect white jumper wire to the back of the controller marked motor white wire. Connect red jumper wire to the back of the controller marked battery red wire. The two red wires from the main connector cannot be connected to the two jumper wires. NOTE: Wires will only connect one way. ANY ATTEMPT TO JOIN THE CONNECTORS IMPROPERLY, FOR EXAMPLE MALE TO MALE, WILL NOT ALLOW THE CONTROLLER TO FUNCTION.
8. Select a suitable location to mount the controller. After mounting verify that the power switch is in the off position.
9. Coil excess wire and use wire ties to secure it to a safe location.
10. Mate the plug coming from the spreader unit to the plug previously installed under the rear bumper.
11. Make sure that feed screw/spinner area of the spreader is clear of obstructions. Turn power on at the controller and verify that the spreader is operating in all modes. Looking down on the impeller from the rear of the vehicle, determine that the impeller is turning counter-clockwise. Unit may now be operated.

Blaster Controller

The controller is equipped with a power on switch, blast switch, vibrator switch and rotary speed control. Once the ignition key is turned to the ON position, the controller face plate will illuminate white indicating that the controller is ready for operation. During operation, face plate color will vary depending on the mode of operation and status of the controller. If the vehicle ignition is shut off while the controller power switch is in the ON or AUTO position the controller will turn off. Once the vehicle ignition is turned back on the controller will not illuminate or turn on unless the controller power switch is first turned off.

To start the spreader, be sure that the vehicle engine is running to prevent battery from wearing down, flip the power switch to position I for normal mode or position II for auto mode. Once power switch is ON, the spreader will power up with 5 full blast for approximately one second then drop to wherever the dial has the speed set at. Adjust the speed of the spreader by rotating the dial clockwise for faster and counter clockwise for slower. The face plate will illuminate green as the speed increases and will change completely to green at maximum speed.

If auto mode is selected, the face plate color will change to amber, the spreader will power up with 5 full blast for approximately one second then drop to wherever the dial has the speed set at. In this mode, if the brake is applied for more than 5 seconds, the spreader will stop and once the brake pedal is released, spreader will resume its operation.

The blast switch provides momentary full power override. During operation if blast switch is depressed, spreader will go onto full speed and the face plate color will change to blue.

If vibrator switch is flipped to the ON position I, vibrator motor will be activated as long as the switch is maintained at position I and the face plate will illuminate purple. If vibrator auto mode is selected at position II, vibrator motor will activate for 10 second every 60 seconds and will cycle the motor ON and OFF as long as the switch is maintained at AUTO position II. Face plate will change color to purple whenever the vibrator motor is activated.

In case there is an overload condition, the face plate will change to red color and the spreader will stop. The Power ON/OFF or AUTO switch will need to be turned OFF to reset the controller.

SPREADING HINTS: Never exceed 10M.P.H. (16kmh) when spreading. For a wider pass, increase spinnners speed. For a heavier pass, drive more slowly. Never operate spreader around people and calculate spread pattern around vegetation.



Spreader Maintenance

Maintenance requirements for the Spreader during the winter season are relatively simple. Periodically inspect for loose bolts and nuts. Inspect for improper ground, broken wires, frayed or cracked wire insulation. Replace as necessary.

WARNING: Disconnect power to spreader before servicing.

CAUTION: Do not attempt to service control unit. It is a solid-state electronic device and has no user serviceable parts; any attempt to do so will void warranty.

CAUTION: The electric motor is sealed and should not be taken apart for any reason. Disassembly of the motor will void warranty.

CAUTION: When replacing parts use only Meyer Products approved parts or risk voiding warranty.

CAUTION: When filling Hopper, make certain there are no large objects contained in the material which could cause the Auger Spinner to bind and stop operation of the Spreader Motor. It is recommended to check for free rotation of the Auger Spinner before operating the Spreader due to possible build up of material between the Auger and neck of the Hopper.

- Use dielectric grease on all electrical connections, before and after each season and whenever the plugs are disconnected. This will ensure long life for the contacts and prevent corrosion.
- Wash unit after each use to prevent material build-up and corrosion.
- Periodically inspect the motor seal located around the shaft and look for cracks or splits. If seal is damaged or missing contact the manufacturer for a replacement.
- At the end of the season thoroughly clean all parts and paint or oil all bare metal surfaces (except for hopper and spinner which are stainless steel and do not require painting). Using a paste wax on the inside of the hopper will help material flow smoothly. OIL SHAFT AT MOTOR BASE TO PREVENT RUST DURING NON-USE.
- Do not attempt to clear Auger or Spinner or to perform any other maintenance or repair work on this Spreader unless the ignition switch is in the "OFF" position and the Motor Plug (28) is disconnected from the Socket Assembly (27).
- Salt must be loose and free from lumps and must be kept dry.
- Empty Hopper after each use and hose the Spreader off.
- When the Spreader is no longer being used, remove it from the vehicle. Remove any rust or corrosion from the metal parts, then prime the paint. Store Spreader in a suitable location and attach weather plug (32) to socket (28) to protect from corrosion.

Spreader Troubleshooting

If your spreader is not operating properly, take it to your local Meyer Products Distributor for maintenance or service. However, that is not always possible, so below on this page you will find a troubleshooting guide, which can assist you in determining the problem.

WARNING – Before performing any service read and understand all safety guidelines stated in this manual.

BEFORE CALLING YOUR DEALER:

Be sure all electrical connections are clean and tight.

Be sure vehicle power supply is working properly (battery charged)

Check the hopper for a jammed feed screw.

PROBLEM	POSSIBLE CAUSE	SOLUTION
Motor does not run.	<ul style="list-style-type: none"> Loose electrical connection. 	<ul style="list-style-type: none"> Check all electrical connections.
Shut Down.	<ul style="list-style-type: none"> Auger or spinner jammed Jammed auger. Poor electrical connections. Electrical short. 	<ul style="list-style-type: none"> Carefully remove jammed material. Carefully remove jammed material. Clean or replace connectors. Look for bare or loose wires.
Material will not feed.	<ul style="list-style-type: none"> No material in the hopper. Material is wet. Frozen or coarse material. Auger loose on motor shaft. Controller bad. 	<ul style="list-style-type: none"> Fill hopper. Replace with dry material. Replace material. Tighten setscrew on side if auger. There is a flat machined into the motor shaft, this set screw must tighten onto that flat. Replace controller.

Material	Base Line	Blaster
CALCIUM CHLORIDE FLAKES		•
CALCIUM CHLORIDE PELLETS	•	•
ROCK SALT WITH BEET JUICE		
ROCK SALT (SMALL GRANULATION)	•	•
ROCK SALT	•	•
CALCIUM CHLORIDE	•	•
ROCK CHIPS		
BAGGED ICE MELT	•	•
LAVA ROCK		
EARLY GMA		
50/50 SAND/SALT MIX		•
SAND		•
PEA GRAVEL		
SHOULDER GRAVEL		

Spreader Calibration

LANE MILE CALIBRATION (US)

DISCHARGE RATE (pounds discharged per mile)

Control Setting	TRAVEL SPEED AND COMPUTATION MULTIPLIER											
	A	B	C	5 mph (C x 12.00)	10 mph (C x 6.00)	15 mph (C x 4.00)	20 mph (C x 3.00)	25 mph (C x 2.40)	30 mph (C x 2.00)	35 mph (C x 1.71)	40 mph (C x 1.50)	45 mph (C x 1.33)
1												
2												
3												
4												
5												
6												
7												
8												
9												
10												

The actual application rate (lbs. per lane mile) on the highway is the discharge rate divided by the number of lanes being treated.

Spreader Calibration Procedure

Calibration is simply calculating the pounds per mile discharged for each control setting at various travel speeds by first counting the number of auger or conveyor shaft revolutions per minute, measuring the weight of salt discharged in one revolution, then multiply the two to obtain discharge per minute, and finally multiplying the discharge per minute by the time it takes to travel 1 mile.

Equipment needed:

1. Scale to weigh salt
2. Salt collection device
3. Marking device
4. Watch with second hand

Calibration steps:

1. Remove spinner assembly.
2. Put partial load of salt in spreader.
3. Mark shaft end of auger.
4. Count number of shaft revolutions per minute at each spreader control setting, record.
5. Collect salt discharged for one revolution, weigh it and deduct the weight of the container. (For greater accuracy, collect salt for several revolutions and divide by that number of revolutions to get the weight for one revolution.)

Spreader Calibration

PARKING LOT CALIBRATION (US)

DISCHARGE RATE (pounds discharged per square foot)

Control Setting	A	B	C	D	E	F	G	H	I	(lbs. discharged per sq. ft.)			
	Shaft RPM (Loaded)	Spread Pattern width (ft.)	Spread Pattern sq. ft. (5 x B) x (.5 x B) x (3.14)/2	Discharge per Auger Revolution (lbs.)	Discharge per Minute (lb) (A x C)	5 mph (D x 12.00)	10 mph (D x 6.00)	15 mph (D x 4.00)	20 mph (D x 3.00)	5 mph F/(C x 5280)	10 mph G/(C x 5280)	15 mph H/(C x 5280)	20 mph I/(C x 5280)
1													
2													
3													
4													
5													
6													
7													
8													
9													
10													

The actual application rate (lbs. per sq. ft.) on the parking lot.

Spreader Calibration Procedure

Calibration is simply calculating the pounds per mile discharged for each control setting at various travel speeds by first counting the number of auger or conveyor shaft revolutions per minute, measuring the weight of salt discharged in one revolution, then multiplying the two to obtain discharge per minute, and finally multiplying the discharge per minute by the time it takes to travel 1 mile.

Equipment needed:

1. Scale to weigh salt
2. Salt collection device
3. Marking device
4. Watch with second hand

Calibration steps:

1. Remove spinner assembly.
2. Put partial load of salt in spreader.
3. Mark shaft end of auger.
4. Count number of shaft revolutions per minute at each spreader control setting, record.
5. Collect salt discharged for one revolution, weigh it and deduct the weight of the container. (For greater accuracy, collect salt for several revolutions and divide by that number of revolutions to get the weight for one revolution.)

Meyer® Base Line Spreader Warranty

Meyer Products, LLC, warrants to the original purchaser of Meyer® brand products that they will be free from defects in materials or workmanship, with the exceptions stated below. No person is authorized to change this warranty or to create any additional warranty on Meyer products.

This warranty runs for a period of one year from the date of purchase on any purchase of a complete BL Spreader Package. If the package is registered on-line at www.meyerproducts.com within sixty (60) days of purchase, your warranty for the Package will be extended for a period of one year. All foregoing warranties apply only to an original purchaser of the product if the product is installed by an authorized Distributor/Sub-Distributor and terminate if the product is sold or otherwise transferred. Some states do not allow limitations on how long an implied warranty lasts, so the above limitation may not apply to you.

- Problems caused by failure to follow the product instructions, failure to maintain the product as described in the Operator's Manual;
- Problems caused by contamination or damage resulting from rust, corrosion, freezing or overheating;
- Paint, or expendable spreader parts such as Auger or Spinner;
- Damage to any vehicle to which the products are mounted;
- Damage caused by usage that is not in accordance with product instructions (use of the spreader for any purpose other than spreading salt/sand is considered misuse and abuse);
- Any spreader, or any part, component, or assembly thereof, which has been modified or altered;
- Problems caused by using accessories, parts, or components not supplied by Meyer Products;
- Cost of tax, freight, transportation or storage charges, environmental charges, solvents, sealants, lubricants or any other normal shop supplies;
- Problems caused by collision, fire, theft, vandalism, riot, explosion, lightning, earthquake, windstorm, hail, water, flood, or any other Acts of God;
- Liability for damage to property, or injury to, or death of any person arising out of the operation, maintenance or use of the covered product;
- Products with missing or altered serial numbers;

The original purchaser's sole and exclusive remedy against Meyer Products and its Distributors and Sub-Distributors, and Meyer Products' sole obligation for any and all claims, whether for breach of contract, warranty, tort (including negligence) or otherwise shall be limited to providing, through its authorized Distributor/Sub-Distributor network, all labor and/or parts necessary to correct such defects free of charge. Any cost incurred in returning the product to an authorized Meyer Distributor/Sub-Distributor is the responsibility of the original purchaser. ALL EXPRESS AND IMPLIED WARRANTIES FOR THE PRODUCT, INCLUDING, WITHOUT LIMITATION, ANY IMPLIED WARRANTIES OF MERCHANTABILITY AND FITNESS FOR A PARTICULAR PURPOSE, ARE LIMITED IN TIME TO THE TERM OF THE LIMITED WARRANTY PERIOD. NO WARRANTIES, WHETHER EXPRESS OR IMPLIED, WILL APPLY AFTER THE LIMITED WARRANTY PERIOD HAS EXPIRED. Meyer Products disclaims liability beyond the remedies provided for in this limited warranty, and disclaims all liability for incidental, consequential, and special damages, including, without limitation, any liability for third-party claims against you for damages, for products not being available for use, or for lost profits. Meyer® Products' liability will be no more than the amount you paid for the product that is the subject of a claim; this is the maximum amount for which we are responsible. Some states do not allow the exclusion or limitation of incidental or consequential damages, so the above limitation or exclusion may not apply to you. A complete BL Spreader Package consists of the Spreader Assembly, operating controller, Spreader Frame and all related items. Structural elements consist of the Spreader Frame, Mounting and Poly Hopper.

Meyer® Base Line Spreader Warranty

Meyer Products will repair any product that proves to be defective in materials or workmanship. In the event repair is not possible or practical (as determined by Meyer Products in its sole discretion), Meyer Products will either replace the product with a new product of similar model and price, or refund the full purchase price, as determined by Meyer Products.

Customer must keep the complete BL Spreader Package serviced/maintained as recommended by Meyer Products. A written record of service must be maintained, along with receipts for maintenance materials purchased. A copy of the maintenance record and pertinent receipts may be requested in the event of a claim.

In order to obtain service under this warranty, the original purchaser must:

- Use all reasonable means to protect the complete BL Spreader package from further damage;
- Return the claimed defective part to the Meyer Distributor/Sub-Distributor from whom the product was purchased or to any authorized Meyer Distributor/Sub-Distributor, transportation and freight charges prepaid. Only Meyer Distributors/Sub-Distributors are authorized to perform the obligations under this warranty. For the address and telephone number of the Meyer Distributor/Sub-Distributor nearest you, check the telephone directory, go to www.meyerproducts.com, write us at the address below, or call (216) 486-1313 for assistance;
- Provide maintenance record and receipts for required maintenance, if requested;
- Allow inspection of damaged parts and/or complete BL Spreader package if deemed necessary by Meyer Products;
- It is the responsibility of the original purchaser to establish the warranty period by verifying the original delivery date; A bill of sale/sales receipt, cancelled check or some other appropriate payment record may be kept for that purpose;

This warranty gives you specific legal rights, and you may also have other rights which vary from state to state.

How to register your Meyer Base Line Spreader to receive the warranty go to www.meyerproducts.com and click on the link to register your plow. Fill out the information on the form as required.

Meyer® Blaster Spreader Warranty

Meyer Products, LLC, warrants to the original purchaser of Meyer® brand products that they will be free from defects in materials or workmanship, with the exceptions stated below. No person is authorized to change this warranty or to create any additional warranty on Meyer® products.

This warranty runs for a period of two years from the date of purchase on any purchase of a complete Blaster Spreader Package. If the Package is registered on-line at www.meyerproducts.com within sixty (60) days of purchase, your warranty for the Package will be extended for a period of three years. All foregoing warranties apply only to an original purchaser of the product if the product is installed by an authorized Distributor/Sub-Distributor and terminate if the product is sold or otherwise transferred. Some states do not allow limitations on how long an implied warranty lasts, so the above limitation may not apply to you.

- Problems caused by failure to follow the product instructions, failure to maintain the product as described in the Operator's Manual;
- Problems caused by contamination or damage resulting from rust, corrosion, freezing or overheating;
- Paint, or expendable spreader parts such as Auger or Spinner
- Damage to any vehicle to which the products are mounted;
- Damage caused by usage that is not in accordance with product instructions (use of the spreader for any purpose other than spreading salt/sand is considered misuse and abuse);
- Any spreader, or any part, component, or assembly thereof, which has been modified or altered;
- Problems caused by using accessories, parts, or components not supplied by Meyer Products;
- Cost of tax, freight, transportation or storage charges, environmental charges, solvents, sealants, lubricants or any other normal shop supplies.
- Problems caused by collision, fire, theft, vandalism, riot, explosion, lightning, earthquake, windstorm, hail, water, flood, or any other Acts of God;
- Liability for damage to property, or injury to, or death of any person arising out of the operation, maintenance or use of the covered product;
- Products with missing or altered serial numbers;

The original purchaser's sole and exclusive remedy against Meyer Products and its Distributors and Sub-Distributors, and Meyer Products' sole obligation for any and all claims, whether for breach of contract, warranty, tort (including negligence) or otherwise shall be limited to providing, through its authorized Distributor/Sub-Distributor network, all labor and/or parts necessary to correct such defects free of charge. Any cost incurred in returning the product to an authorized Meyer® Distributor/Sub-Distributor is the responsibility of the original purchaser. ALL EXPRESS AND IMPLIED WARRANTIES FOR THE PRODUCT, INCLUDING, WITHOUT LIMITATION, ANY IMPLIED WARRANTIES OF MERCHANTABILITY AND FITNESS FOR A PARTICULAR PURPOSE, ARE LIMITED IN TIME TO THE TERM OF THE LIMITED WARRANTY PERIOD. NO WARRANTIES, WHETHER EXPRESS OR IMPLIED, WILL APPLY AFTER THE LIMITED WARRANTY PERIOD HAS EXPIRED. Meyer Products disclaims liability beyond the remedies provided for in this limited warranty, and disclaims all liability for incidental, consequential, and special damages, including, without limitation, any liability for third-party claims against you for damages, for products not being available for use, or for lost profits. Meyer Products' liability will be no more than the amount you paid for the product that is the subject of a claim; this is the maximum amount for which we are responsible. Some states do not allow the exclusion or limitation of incidental or consequential damages, so the above limitation or exclusion may not apply to you. A complete Blaster Spreader Package consists of the Spreader Assembly, operating controller, Spreader Frame and all related items. Structural elements consist of the Spreader Frame, Mounting and Poly Hopper.

Meyer® Blaster Spreader Warranty

Meyer Products will repair any product that proves to be defective in materials or workmanship. In the event repair is not possible or practical (as determined by Meyer Products in its sole discretion), Meyer Products will either replace the product with a new product of similar model and price, or refund the full purchase price, as determined by Meyer Products.

Customer must keep the complete Blaster Spreader Package serviced/maintained as recommended by Meyer Products. A written record of service must be maintained, along with receipts for maintenance materials purchased. A copy of the maintenance record and pertinent receipts may be requested in the event of a claim.

In order to obtain service under this warranty, the original purchaser must:

- Use all reasonable means to protect the complete Blaster Spreader package from further damage;
- Contact your local Meyer® or Aebi-Schmidt dealer from whom the product was purchased or to any authorized Meyer® or Aebi-Schmidt dealer. Transportation and freight charges prepaid when applicable. Only Meyer® and Aebi-Schmidt dealers are authorized to perform the obligations under this warranty. For the address and telephone number of the Meyer® or Aebi-Schmidt dealer nearest you visit <https://www.meyerproducts.com/dealer-locator>.
- Provide maintenance record and receipts for required maintenance, if requested;
- Allow inspection of damaged parts and/or complete Blaster Spreader package if deemed necessary by Meyer Products.
- It is the responsibility of the original purchaser to establish the warranty period by verifying the original delivery date. A bill of sale/sales receipt, cancelled check or some other appropriate payment record may be kept for that purpose.

This warranty gives you specific legal rights, and you may also have other rights which vary from state to state.

EC Declaration of Conformity

The undersigned representing the manufacturer...

Meyer Products LLC
18513 Euclid Ave
Cleveland, OH 4412

herewith declared that product: HomePlow, WingMan, DrivePro, DriveProLightDuty, LotPro, LotProLightDuty, RoadPro32, DiamondEdge2, SuperBlade, Super-V, Super-V2, Super-V3, NiteSaberIII Lights, NiteSaberLED Lights, BaseLine, Blaster, Crossfire, Elite, MDV, Polyhawk is in conformity with the essential requirements of the following EC directives when subject to correct installation, maintenance, and use conforming to its (their) intended purpose, to the applicable regulations and standards, to our operation and maintenance manual.

- 2014/35/EU - EC Low Voltage Directive
- 2014/30/EU - EMC Directive
- 2006/42/EC - Machinery Directive

and that the standards and/or technical specifications referenced below have been applied:

- CEN EN 13021 Issue: 2003/05/01 WINTER SERVICE MACHINES - SAFETY REQUIREMENTS; AMD A1: 2008/12/01
- BS EN 60204-1:2018 Safety of machinery. Electrical equipment of machines. General requirements
- CEN EN ISO 4413 Issue: 2010/11/01 HYDRAULIC FLUID POWER - GENERAL RULES AND SAFETY REQUIREMENTS FOR SYSTEMS AND THEIR COMPONENTS
- Essential Health and safety requirements per Annex I of 2006/42/EC
- EN ISO 12100:2010 Safety of machinery - General principles for design - Risk assessment and risk reduction
- EN 50498:2010

Notes

Notes

Notes

Meyer Products carries a full line of spreaders and other products including:



Broadcast Spreaders

If you are looking for a heavy-duty broadcast spreader for all-season use, look no further.



Insert Hopper

Featuring an unprecedented ten-year warranty on the virtually indestructible polyethylene hopper, Meyer outlasts virtually every hopper on the market.



2" Receiver Plows

Perfect for smaller trucks and SUVs for home use.



Professional Plows

For larger municipality, roadway, and parking lot applications.

Meyer Products LLC
18513 Euclid Avenue
Cleveland, OH 44112-1084
216-486-1313
www.meyerproducts.com

Dealer Information: